

# PYROVIEW compact

## Infrared cameras for universal applications

Non-contact temperature measurements from  
-20 °C to 2500 °C

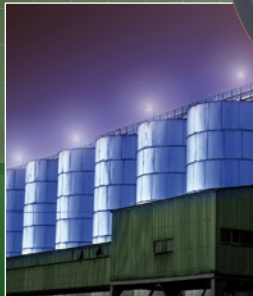

alarm monitoring bulk-materials data export data transmission long-term-use fast-ethernet fire  
surveillance fixed-mount food gigabit-ethernet glas high-dyn  
mic high-temperature-ranges industry microbolometer-arrays non-contact  
per plastics precise quality-control real-time robust Si-CMOS-Array software  
steel-industry stand-alone-operation threshold-monitoring trend-analysis two-dimensiona

## PYROVIEW compact: Non-contact temperature measurement of two-dimensional temperature distributions



Our infrared camera series **PYROVIEW compact** allows you non-contact measurement of two-dimensional temperature distributions with high thermal and spatial resolution. All models are specially designed for longterm use in fixed-mount applications.

For general measurements the spectral ranges from 8  $\mu\text{m}$  to 14  $\mu\text{m}$  and 3  $\mu\text{m}$  to 5  $\mu\text{m}$  are available whereas the spectral range 4.8  $\mu\text{m}$  to 5.2  $\mu\text{m}$  is destined for special glass measurements. The spectral range around 3.9  $\mu\text{m}$  is suitable for measurements through flames and flue gas. High temperatures can be measured at 0.8  $\mu\text{m}$  to 1.1  $\mu\text{m}$ .

Different lenses allow measurement results at the best. With real-time data acquisition via Fast Ethernet and Gigabit-Ethernet respectively images can be transferred to a computer with a test frequency of maximum 50 images per second. Stand-alone operation without computer is possible as well.

Alarm and threshold monitoring as well as triggered measurements belong to the functional range of PYROVIEW compact. The cameras are in an aluminium or a stainless steel compact housing.

We grant you 2 years warranty and customized system solutions with modified hardware and software.

## Fast and dynamic: PYROVIEW 380 and 320 compact

Typical applications of our camera series PYROVIEW compact are process control and monitoring, quality control, fire surveillance as well as measurements in research and development.

### PYROVIEW 380 compact with 384 × 288 pixels

|                              | Spectral range <sup>1</sup>            | Measurement range <sup>1</sup>                          | NETD <sup>2</sup>        |
|------------------------------|--|---|--------------------------|
| <b>PYROVIEW 380L compact</b> | 8 $\mu\text{m}$ to 14 $\mu\text{m}$    | Range 1: -20 °C to 120 °C<br>Range 2: 0 °C to 500 °C    | 0.08 K<br>(30 °C, 50 Hz) |
| <b>PYROVIEW 380M compact</b> | 3 $\mu\text{m}$ to 5 $\mu\text{m}$     | Range 1: 100 °C to 300 °C<br>Range 2: 200 °C to 500 °C  | 0.5 K<br>(200 °C, 50 Hz) |
| <b>PYROVIEW 380G compact</b> | 4.8 $\mu\text{m}$ to 5.2 $\mu\text{m}$ | Range 1: 200 °C to 500 °C<br>Range 2: 400 °C to 1250 °C | 1 K<br>(300 °C, 50 Hz)   |
| <b>PYROVIEW 380F compact</b> | 3.9 $\mu\text{m}$                      | 600° C to 1250 °C                                       | 1 K<br>(600 °C, 50 Hz)   |

Optics with motor or manual focussing.  
Standard field of view: 30° × 23°  
Optional: 43° × 33°, 22° × 16°, 11° × 8°, 7° × 5°<sup>3</sup>, Macro 60  $\mu\text{m}$  (L-Version)  
51° × 40°, 15° × 12° (M-, G-, F-Version)



Paper storage control

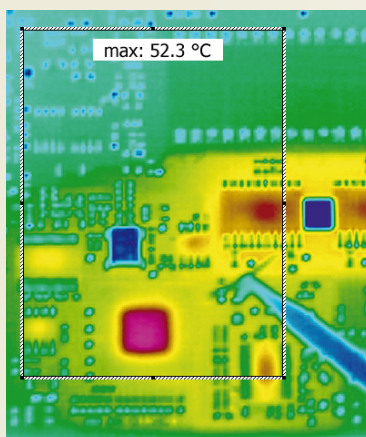

Conductor plate

### PYROVIEW 320 compact with 320 × 240 pixels

|                              | Spectral range <sup>1</sup>            | Measurement range <sup>1</sup>                          | NETD <sup>2</sup>        |
|------------------------------|--|---|--------------------------|
| <b>PYROVIEW 320L compact</b> | 8 $\mu\text{m}$ to 14 $\mu\text{m}$    | Range 1: -20 °C to 120 °C<br>Range 2: 0 °C to 500 °C    | 0.08 K<br>(30 °C, 50 Hz) |
| <b>PYROVIEW 320M compact</b> | 3 $\mu\text{m}$ to 5 $\mu\text{m}$     | Range 1: 100 °C to 300 °C<br>Range 2: 200 °C to 500 °C  | 0.5 K<br>(200 °C, 50 Hz) |
| <b>PYROVIEW 320G compact</b> | 4.8 $\mu\text{m}$ to 5.2 $\mu\text{m}$ | Range 1: 200 °C to 500 °C<br>Range 2: 400 °C to 1250 °C | 1 K<br>(300 °C, 50 Hz)   |
| <b>PYROVIEW 320F compact</b> | 3.9 $\mu\text{m}$                      | 600° C to 1250 °C                                       | 1 K<br>(600 °C, 50 Hz)   |

Optics with motor or manual focussing.  
Standard field of view: 25° × 19°  
Optional: 37° × 28°, 18° × 14°, 9° × 7°, 6° × 5°, Macro 60  $\mu\text{m}$  (L-Version)  
44° × 33°, 13° × 10° (M-, G-, F-Version)

# made in Germany.

## Reliable, robust, accurate and high-definition: PYROVIEW 640 compact



Fire surveillance

### PYROVIEW 640L compact with 640 × 480 pixels

|                              | Spectral range <sup>1</sup> | Measurement range <sup>1</sup>                       | NETD <sup>2</sup>        |
|------------------------------|-----------------------------|--|--------------------------|
| <b>PYROVIEW 640L compact</b> | 8 μm to 14 μm               | Range 1: -20 °C to 120 °C<br>Range 2: 0 °C to 500 °C | 0.08 K<br>(30 °C, 50 Hz) |

Optics with motor or manual focussing.  
Standard field of view 36° × 27°  
Optional 18° × 14°, 12° × 9°<sup>3</sup>, macro lens 60 μm

### PYROVIEW 640N compact with 640 × 480 pixels

|                              | Spectral range <sup>1</sup> | Measurement range <sup>1</sup>         | NETD <sup>2</sup>       |
|------------------------------|-----------------------------|--|-------------------------|
| <b>PYROVIEW 640N compact</b> | 0.8 μm to 1.1 μm            | 600 °C to 1500 °C,<br>optional 2500 °C | <2 K<br>(600 °C, 25 Hz) |

Optics with manual focussing.  
Standard field of view 32° × 24°  
Optional 46° × 35°, 23° × 17°, 17° × 13°, borescope lens 71° × 55° (PYROINC 640N)



## Extensive accessories

### Software PYROSOFT

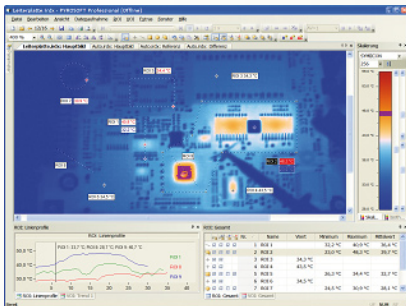

The powerful online software PYROSOFT for Windows® allows you to control the infrared camera PYROVIEW compact. Recording, viewing, manipulation and storage of the measured data are possible as well. Special features are:

- Real-time data recording
- Definition of zones and monitoring of alarm thresholds
- Analysis of trends
- Data export (text, bitmap, video)
- Process control via PROFIBUS, analog and digital inputs, outputs, and other interfaces

A programming interface (Windows®-DLL) is available for system integration.

### Optional camera housings



Industrial housing IP 65 with water cooling system and air purge



ATEX housing



Water cooling housing



Weatherproof housing with pan-tilt-unit

<sup>1</sup> Others available. <sup>2</sup> Specification for black body reference and ambient temperature 25 °C.

<sup>3</sup> NETD < 0,2 K (30 °C, 50 Hz). <sup>4</sup> Gigabit-Ethernet (PYROVIEW 640L compact), otherwise Fast Ethernet.

<sup>5</sup> Export version with < 9 Hz available.

Your manufacturer and partner  
for industrial infrared systems

- R & D, manufacturing, sales, and service from one source
- German quality and reliability
- Two years warranty
- Certified to ISO 9001 for many years

Our product range includes:

- Pyrometers
- Infrared line cameras
- Thermal imaging cameras
- Infrared detectors
- Measurement and calibration equipment
- System solutions

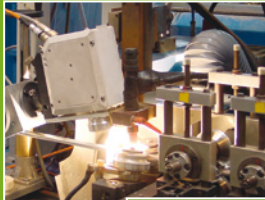

Our dedicated experts are able to offer you the benefits of 25 years of practical and technical experience in infrared technology.

For any questions contact us!

DIAS Infrared GmbH  
Gostritzer Straße 65  
01217 Dresden • Germany

Telephone: +49 351 871 7228  
Telefax: +49 351 871 7230

E-mail: [info@dias-infrared.de](mailto:info@dias-infrared.de)  
Web: [www.dias-infrared.com](http://www.dias-infrared.com)



certificated after  
ISO 9001:2008

Technical details are subject to change.  
March 2010.

## More technical data

|  | PYROVIEW 320, 380 und 640L compact                               | PYROVIEW 640N compact  |
|--|--|--|
| <b>Sensor</b>                              | Uncooled microbolometer array                                    | High dynamic 2D Si-CMOS-array (640 × 480 pixels)                 |
| <b>Measurement uncertainty<sup>2</sup></b> | 2 K (measured temperature < 100 °C) or 2 % of measured value     | 2 % of measured value (object temperature < 1000 °C)             |
| <b>Measurement frequency<sup>5</sup></b>   | Internal 50 Hz, selectable: 50 Hz, 25 Hz, 12.5 Hz,...            | Internal 25 Hz, selectable: 25 Hz, 12.5 Hz, 6.25 Hz,...          |
| <b>Response time</b>                       | Internal 40 ms, selectable: 2/measurement frequency              | Internal 80 ms, selectable: 2/measurement frequency              |
| <b>Interfaces</b>                          | Ethernet <sup>4</sup> (real-time 50 Hz)                          | Fast Ethernet (real-time 25 Hz)                                  |
| <b>Digital inputs</b>                      | 2 electrically isolated digital inputs (trigger)                 |  |
| <b>Digital outputs</b>                     | 2 electrically isolated digital outputs (alarm)                  |  |
| <b>Power supply</b>                        | 10 V to 36 V DC, typical 4 VA to 10 VA                           |  |
| <b>Camera housing</b>                      | Aluminium compact housing IP 54                                  | Stainless steel compact housing                                  |
| <b>Dimensions</b>                          | 85 mm (L) × 175 mm (W) × 107 mm (H), without lens and connectors | 60 mm (L) × 160 mm (W) × 60 mm (H), without lens and connectors, |
| <b>Operating temperature range</b>         | -10 °C to 50 °C  |  |
| <b>Storage conditions</b>                  | -20 °C to 70 °C, 95 % relative humidity                          |  |

<sup>1</sup> Others available. <sup>2</sup> Specification for black body reference and ambient temperature 25 °C. <sup>3</sup> NETD < 0.2 K (30 °C, 50 Hz). <sup>4</sup> Gigabit-Ethernet (PYROVIEW 640L compact), otherwise Fast Ethernet. <sup>5</sup> Export version with < 9 Hz available.

## System configuration with Ethernet interface

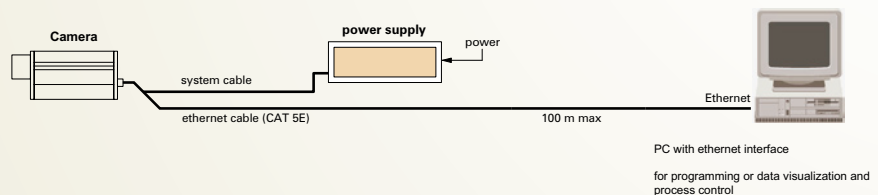
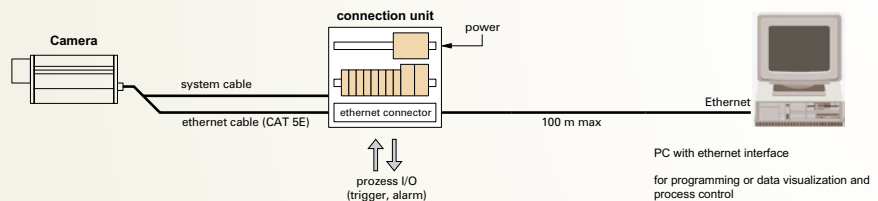

## Dimensions

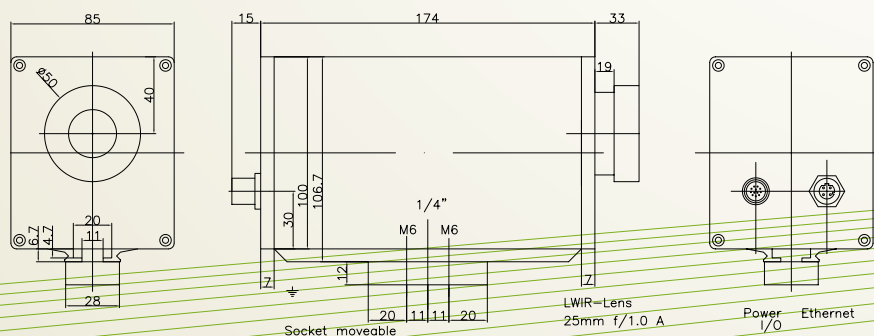

PYROVIEW 320, 380 and 640L compact